

### Triac 30 Ampere/400-600 Volts

#### OUTLINE DRAWING

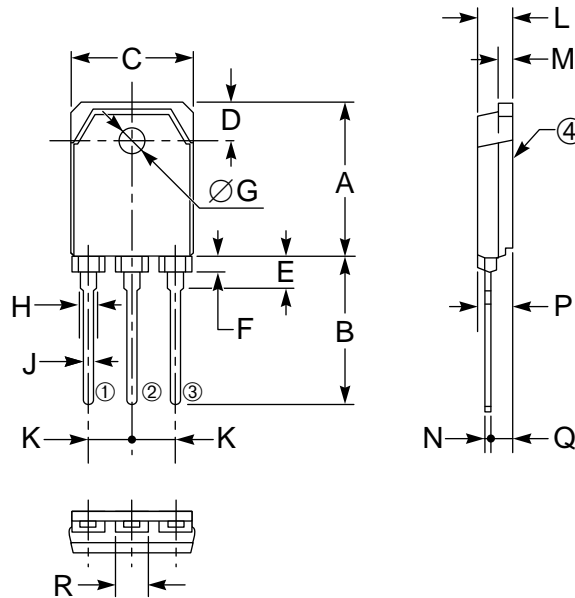

#### CONNECTION DIAGRAM

- ① T1 TERMINAL
- ② T2 TERMINAL
- ③ GATE
- ④ T2 TERMINAL

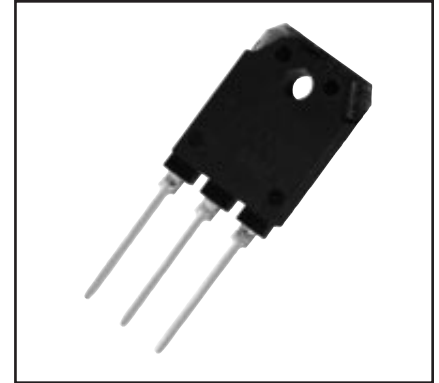
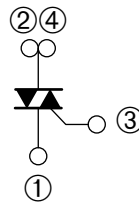

#### Description:

A triac is a solid state silicon AC switch which may be gate triggered from an off-state to an on-state for either polarity of applied voltage.

#### Features:

- Planar Passivation
- Selected for Inductive Loads

#### Applications:

- Contactless AC Switches
- Microwave Ovens
- Motor Controls
- Lighting Controls

#### Ordering Information:

Example: Select the complete eight, nine or ten digit part number you desire from the table - i.e. BCR30AM-8 is a 400 Volt, 30 Ampere Triac.

Outline Drawing (Conforms to TO-3P)

Dimensions	Inches	Millimeters
A	0.79	20.0
B	0.77	19.5
C	0.63	15.9
D	0.20	5.0
E	0.16	4.0
F	0.08	2.0
G	0.13 Dia.	3.2 Dia.
H	0.08	2.0

Dimensions	Inches	Millimeters
J	0.04	1.0
K	0.21	5.45
L	0.18	4.5
M	0.06	1.5
N	0.02	0.6
P	0.17	4.4
Q	0.11	2.8
R	0.16	4.0

Type	V <sub>DRM</sub> Volts	Code	Inductive Load*
BCR30AM	400	-8	L
	600	-12	

\*For inductive load, add L.

## BCR30AM

### Triac

30 Ampere/400-600 Volts

### Absolute Maximum Ratings, $T_a = 25\text{ }^\circ\text{C}$ unless otherwise specified

Ratings	Symbol	BCR30AM-8	BCR30AM-12	Units
On-state Current, $T_c = 75^\circ\text{C}$	$I_{T(RMS)}$	30	30	Amperes
Repetitive Peak Off-state Voltage (Gate Open)	$V_{DRM}$	400	600	Volts
Non-repetitive Peak Off-state Voltage (Gate Open)	$V_{DSM}$	500	720	Volts
Non-repetitive Peak On-state Voltage, One Cycle (60 Hz)	$I_{TSM}$	300	300	Amperes
$I^2t$ for Fusing, $t = 8.3\text{ msec}$	$I^2t$	378	378	$\text{A}^2\text{sec}$
Peak Gate Power Dissipation, $20\text{ }\mu\text{sec}$	$P_{GM}$	5	5	Watts
Average Gate Power Dissipation	$P_{G(avg)}$	0.5	0.5	Watts
Peak Gate Current	$I_{GM}$	2	2	Amperes
Peak Gate Voltage	$V_{GM}$	10	10	Volts
Storage Temperature	$T_{stg}$	-40 to 125	-40 to 125	$^\circ\text{C}$
Operating Temperature	$T_j$	-40 to 125	-40 to 125	$^\circ\text{C}$
Weight	–	4.8	4.8	Grams

### Electrical and Thermal Characteristics, $T_j = 25\text{ }^\circ\text{C}$ unless otherwise specified

Characteristics	Symbol	Test Conditions (Trigger Mode)				BCR30GM			Units
		$V_D$	$R_L$	$R_G$	$T_j$	Min.	Typ.	Max.	
Gate Parameters									
DC Gate Trigger Current									
MT2+ Gate+	$I_{FGT\ I}$	6V	6 $\Omega$	330 $\Omega$	25 $^\circ\text{C}$	–	–	50	mA
MT2+ Gate–	$I_{RGT\ I}$	6V	6 $\Omega$	330 $\Omega$	25 $^\circ\text{C}$	–	–	50	mA
MT2– Gate–	$I_{RGT\ III}$	6V	6 $\Omega$	330 $\Omega$	25 $^\circ\text{C}$	–	–	50	mA
DC Gate Trigger Voltage									
MT2+ Gate+	$V_{FGT\ I}$	6V	6 $\Omega$	330 $\Omega$	25 $^\circ\text{C}$	–	–	2.5	Volts
MT2+ Gate–	$V_{RGT\ I}$	6V	6 $\Omega$	330 $\Omega$	25 $^\circ\text{C}$	–	–	2.5	Volts
MT2– Gate–	$V_{RGT\ III}$	6V	6 $\Omega$	330 $\Omega$	25 $^\circ\text{C}$	–	–	2.5	Volts
DC Gate Non-trigger Voltage									
All	$V_{GD}$	1/2 $V_{DRM}$	–	–	125 $^\circ\text{C}$	0.2	–	–	Volts

Characteristics	Symbol	Test Conditions	Min.	Typ.	Max.	Units
Thermal Resistance, Junction-to-case	$R_{th(c-f)}$	–	–	–	1.2	$^\circ\text{C}/\text{W}$
Voltage – Blocking State Repetitive Off-state Current	$I_{DRM}$	Gate Open Circuited, $V_D = V_{DRM}$ , $T_j = 125^\circ\text{C}$	–	–	3	mA
Current – Conducting State Peak On-state Voltage	$V_{TM}$	$T_c = 25^\circ\text{C}$ , $I_{TM} = 45\text{A}$	–	–	1.6	Volts
Critical Rate-of-Rise of Commutating Off-state Voltage (Commutating $dv/dt$ ) ▲ (Switching)	$(dv/dt)_c$	–	–	–	–	$\text{V}/\mu\text{s}$



Powerex, Inc., 200 Hillis Street, Youngwood, Pennsylvania 15697-1800 (412) 925-7272

**BCR30AM**

**Triac**

30 Ampere/400-600 Volts

**MAXIMUM ON-STATE CHARACTERISTICS**

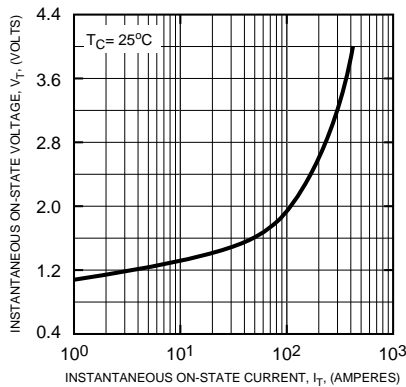

**TRANSIENT THERMAL IMPEDANCE CHARACTERISTICS**

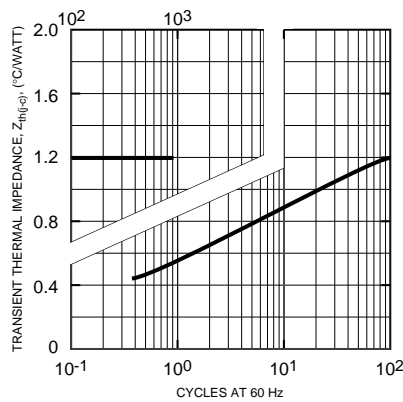

**GATE CHARACTERISTICS (I, II, III)**

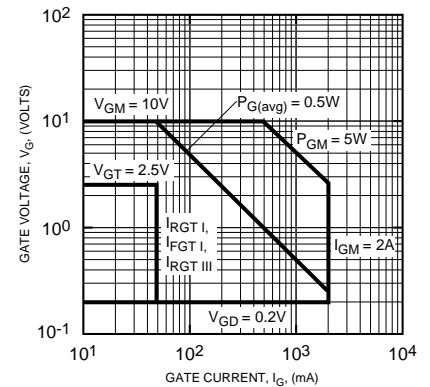

**MAXIMUM SURGE CURRENT FOLLOWING RATED LOAD CONDITIONS**

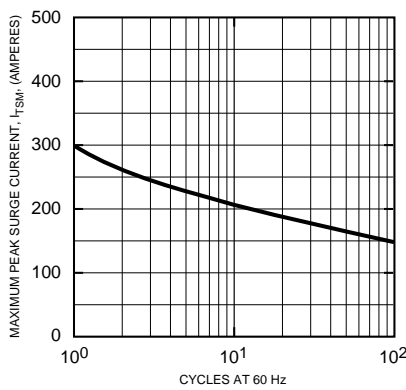

**ALLOWABLE CASE TEMPERATURE VS. RMS ON-STATE CURRENT**

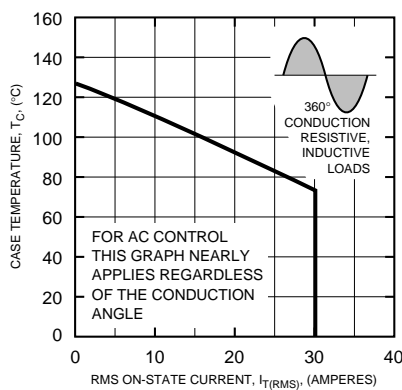

**ALLOWABLE AMBIENT TEMPERATURE VS. RMS ON-STATE CURRENT**

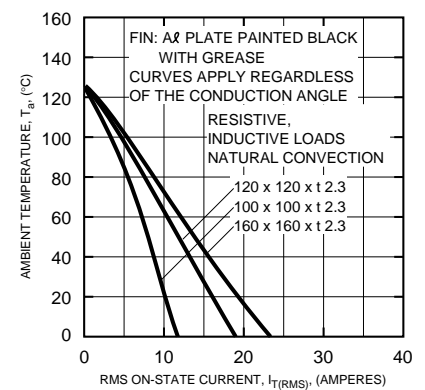

**MAXIMUM ON-STATE POWER DISSIPATION**

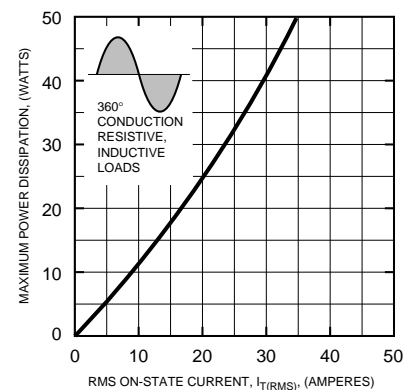

**GATE TRIGGER CURRENT VS. JUNCTION TEMPERATURE (TYPICAL)**

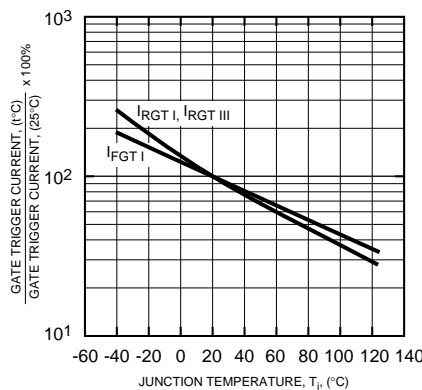

**GATE TRIGGER VOLTAGE VS. JUNCTION TEMPERATURE (TYPICAL)**

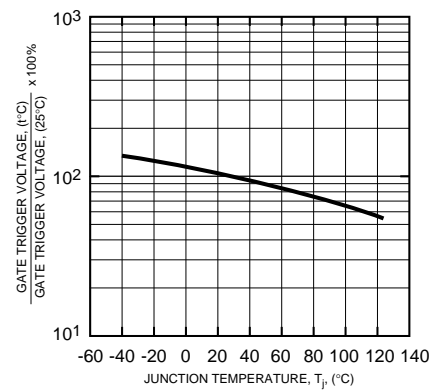

## BCR30AM

### Triac

30 Ampere/400-600 Volts

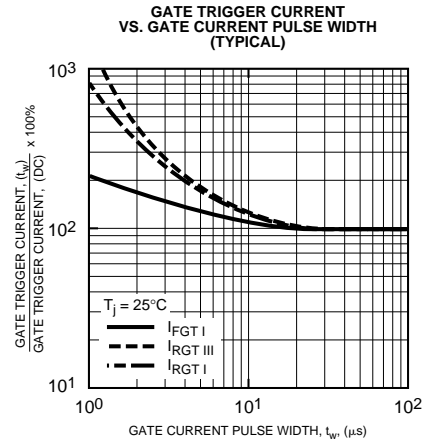
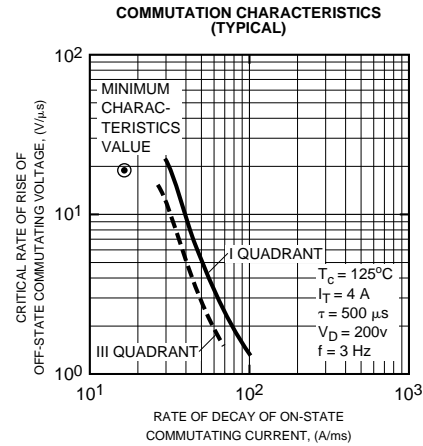
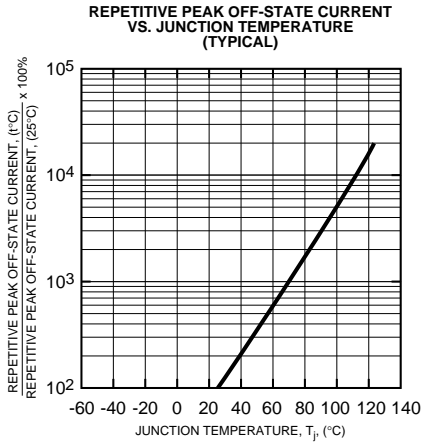
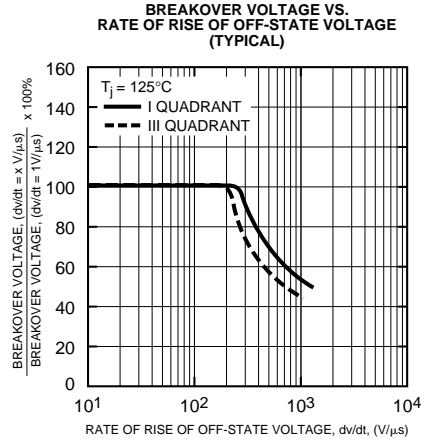
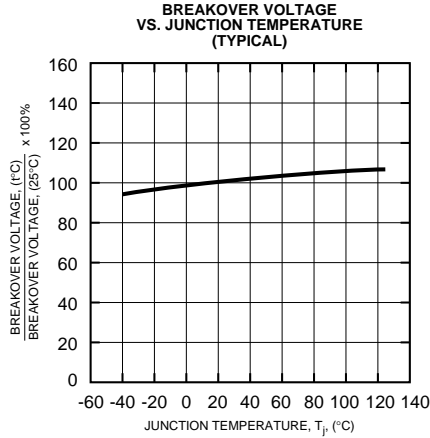
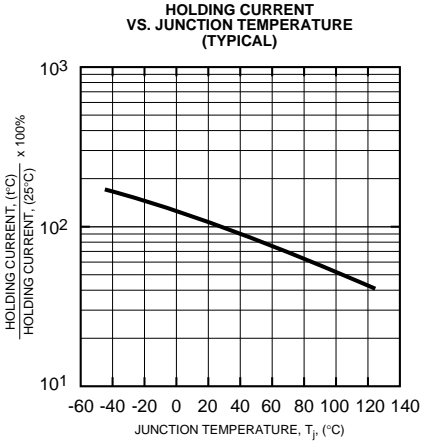

**GATE TRIGGER CHARACTERISTICS TEST CIRCUITS**

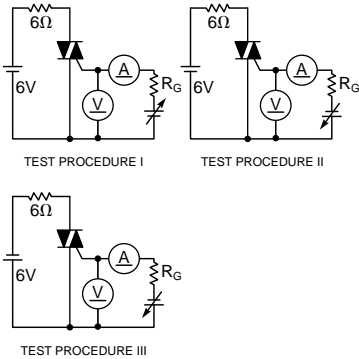

Δ Part Number	V <sub>DRM</sub> (Volts)	Commutating dv/dt, (dv/dt) <sub>C</sub> (V/μsec)		Test Condition	Commutating Voltage & Current Waveform (Inductive Load)
		Minimum	Maximum		
BCR30AM-8L	400	20		$T_j = 125^\circ\text{C}$ , Rate of Decay On-state Commutating Current (di/dt) <sub>C</sub> = -016A/msec, Peak Off-state Voltage $V_D = 400\text{ V}$	
BCR30AM-12L	600	20			